



RICHMOND
THE AMERICAN INTERNATIONAL
UNIVERSITY
IN LONDON

BA (Hons) Communications with Combined Studies

Programme Specification

2018-2019

Introduction

This document describes the three concentrations of the degree of BA (Hons) Communications with Combined Studies awarded by Richmond University, the American International University in London, using the protocols required by the *The Framework for Higher Education Qualifications in England, Wales, and Northern Ireland* (QAA, 2014). Also key to the background for this description are the following documents:

QAA (2013). *UK Quality Code for Higher Education. Part A: Setting and maintaining academic standards and B1: Programme Design and Approval.* (www.qaa.ac.uk)

QAA (2008). *Higher Education Credit Framework for England: guidance on academic credit arrangements in Higher Education in England.*

SEEC (2010). *Credit Level Descriptors for Higher Education.* Southern England Consortium for Credit Accumulation and Transfer (www.seec.org.uk).

Middle States Commission on Higher Education. *Standards for Accreditation and Requirements of Affiliation. 2014: Thirteenth Edition; Rev. Ed. 2015.* (<http://www.msche.org/publications/RevisedStandardsFINAL.pdf>)

The degree is delivered within the framework of a US Liberal Arts undergraduate degree programme. Typically students complete 40 separate courses over the programme which takes 3.5 to 4 years (approximately 10 courses per year, with summer courses allowing for accelerated progress in some cases). Normally, each course carries 3 US academic credits (equivalent, approximately, to 3 classroom contact hours per 15 week semester). On this basis, students are required to earn a total of 120 US academic credit hours in order to complete their degrees. Of these 40 courses, roughly half are at the “lower-division” taken in the first two years of study and coded 3000-4999, and half are at the “upper division”, taken in years three and four, and coded 5000-6999.

Richmond degrees are also articulated in terms of UK Regulatory Frameworks, chiefly the *FHEQ* and the *Higher Education Credit Framework for England*. Each course has been assigned to an appropriate level on the *FHEQ*, based on the course’s learning outcomes and assessment strategies (note that the courses comprising the first year of the 4-year US undergraduate degree are normally at RQF Level 3). US undergraduate credit can generally be translated to ECTS and UK CATS credits in the following manner: 1 US credit = 2 ECTS credits = 4 UK CATS credits. So a US degree of 120 credits would translate as 240 ECTS credits and 480 UK CATS credits (with a minimum of 360 UK CATS credits at Levels 4-6 on the *FHEQ*).

Contents

This is an interactive Table of Contents. To go directly to the Chapter, place the mouse over the chapter title, and press Ctrl and click to follow the link.

1. Overview/Factual Information	4
2. Programme aims and objectives	6
2.1. Educational aims of the programme	6
2.2. Subject benchmarks	8
2.3. Internal contexts	8
2.4. External contexts	9
3. Programme outcomes	10
3.1. Key Programme Outcomes	10
3.2. Theoretical Knowledge Base (“A”)	10
3.3. Practical Knowledge Base (“B”)	11
3.4. Cognitive Skills (“C”)	12
3.5. Personal Development (“D”)	13
4. Teaching, learning and assessment strategies	14
4.1. Teaching and learning strategy	14
4.2. Assessment strategy	15
5. Programme structure:	18
5.1. BA (Hons) Communications with Combined Studies	18
<i>Table 1: Lower-Division / Levels 3 and 4 Degree Requirements</i>	18
<i>Table 2: Upper-Division/Levels 5 and 6 Requirements: Marketing and PR Pathway</i>	19
<i>Table 3: Upper-Division/Levels 5 and 6 Requirements: Media Studies Pathway</i>	20
<i>Table 4: Upper-Division/Levels 5 and 6 Requirements: Media Production Pathway</i>	21
<i>Courses in Italy</i>	22
5.2. Exit Award Requirements	25
5.2.1. Associate of Arts Degree in General Studies (US)	25
5.2.2. Certificate of Higher Education (UK)	25
5.2.3. Diploma of Higher Education (UK)	26
5.3. Minor requirements	27
6. Distinctive Features and Regulatory Framework	27
6.1 Admissions	28
6.2 Assessment	29
6.3 Progression	29
6.4 Placement	29
6.5 Study abroad and Visiting Students	29
6.6 Student support and guidance	30
Appendix I - Curriculum map	32
Appendix 2 – Programme Structure Flowchart: BA (Hons) Communications with Combined Studies	37
A. MARKETING and PUBLIC RELATIONS Pathway.	37
B. MEDIA STUDIES Pathway.	38
C. MEDIA PRODUCTION Pathway.	39

1. Overview/Factual Information

Programme/award title(s)	BA (Hons) Communications: Marketing and Public Relations with Combined Studies BA (Hons) Communications: Media Studies with Combined Studies BA (Hons) Communications: Media Production with Combined Studies
Teaching Institution	Richmond, the American International University in London
Awarding Institution	Richmond, the American International University in London
Date of latest OU validation	1 September 2012
Next revalidation	2016/2017
Credit points for the award	120 US Credits 480 UK Credits at <i>FHEQ</i> Levels 3-6 (120 at Level 3; 120 at Level 4; 120 at Level 5; 120 at Level 6)
UCAS Code	University Code: R20 Marketing and Public Relations: NP52 Media Production: P310 Media Studies: P300
Programme start date	September 1998
Underpinning QAA subject benchmark(s)	Communication, Media, Film and Cultural Studies (2008) http://www.qaa.ac.uk/assuring-standards-and-quality/the-quality-code/subject-benchmark-statements/honours-degree-subjects
Other external and internal reference points used to inform programme outcomes	See sections 2.3 and 2.4 below.
Professional/statutory recognition	N/A
Language of Study	English
Duration of the programme for each mode of study (P/T, FT,DL)	FT
Dual accreditation (if applicable)	Middle States Commission on Higher Education (First accredited 1981; renewed 1996, 2006 and 2016.) QAA – Higher Education Review (AP) December 2017
Date of production/revision of this specification	April 2016

Please note: This specification provides a concise summary of the main features of the programme and the learning outcomes that a typical student might reasonably be expected to achieve and demonstrate if s/he takes full advantage of the learning opportunities that are provided.

More detailed information on the learning outcomes, content, and teaching, learning and assessment methods of each course can be found in course specification documents, syllabi, and the student handbook.

The accuracy of the information contained in this document is reviewed by the University and may be verified by the Quality Assurance Agency for Higher Education.

Programme Specification Publication Dates

Document publication date	July 2007
Revision 1	February 2008
Revision 2	January 2009
Revision 3	May 2010
Revision 4	February 2012
Revision 5 (substantive revision, including <i>FHEQ</i> and credit mapping)	June 2012
Revision 6	June 2013
Revision 7	May 2014
Revision 8	May 2015
Revision 9	April 2016
Revision 10	April 2017
Revision 11	May 2017

2. Programme aims and objectives

2.1. Educational aims of the programme

MISSION

The BA (Hons) Communications with Combined Studies degree prepares students to work within the technologically driven, global, communication revolution of the 21st Century, and helps students develop as leaders in their careers and communities. The Major provides an interdisciplinary, multimedia approach to the study of Communication, and through its core courses and special programs develops an intercultural and global awareness within the framework of the liberal arts tradition.

GOALS

- To develop a broad understanding of the theory and practice of Communication Studies.
- To competently integrate the knowledge and skills acquired in the course of studying for the UK BA (Hons) Communications with Combined Studies within a US Liberal Arts framework.
- To equip students with the skills necessary to undertake successful postgraduate study and/or applied professional training after graduation.
- To maintain academic standards equal to or better than comparable BA degrees offered by UK universities.

BA (Hons) Communications with Combined Studies aims to provide students with:

- A full development of each student's aesthetic and intellectual potential by means of a student-centred classroom and a full range of assessments designed to measure the acquisition of both theoretical and practical skills.
- The maximum use of the particular cultural environment in which the degree is delivered, both in terms of the university itself and the broader context of the cultural life of London.
- The pursuit of knowledge against the changing backdrop of globalisation and rapidly advancing technologies.
- The provision of a degree which acknowledges the implicit connection between a student's university education and future career by developing knowledge and skills which will be valuable and valued in the international marketplace.

BA (Hons) Communications with Combined Studies is distinctive in that it broadens the academic experience of the students as a consequence of Richmond's US Liberal Arts framework and General Education requirements, and deepens it as a result of the sequence of course requirements within the program. This balance between a core of requirements and a range of choices is a key characteristic of the US system of Liberal Arts undergraduate education which does not strive nor wish to replicate the British specialist orientation at the BA level. From this unique stance, the Richmond

programme, launched in 1994, combines the best possible theory and practice from both sides of the Atlantic. Operating from a firm, theoretical interdisciplinary base, the degree provides an exploration of the central role and function of communications as a “maker of meaning” and as a social and political force, and seeks to achieve specific learning outcomes based on fundamental understanding of principles of message and audience, content and medium, form, style, documentation, dissemination and reproduction.

Communications is one of the fastest growing disciplines in undergraduate education. The unique structure of the Richmond degree programme allows the flexibility necessary to reflect this growth. The programme is constructed around a common core of courses (taken at the same time as General Education/Combined Studies courses) in the first and second years. These are followed by specialized third and fourth year courses, culminating in Senior Seminar I and II (theoretical final year courses) for which students complete an extensive, original research project using primary and secondary research resources and the Senior Project (practical final year course) during which their practical skills are put to the test working on a project for a real client from outside the university. This balance of theoretical and practical course offerings, with many faculty active practitioners in their field, achieves appropriate preparation for students going into relevant postgraduate study and/or related careers.

A further distinctive feature of the Richmond programme is that it is able to meet the wide ranging, specific needs of an international student body. To achieve this, the programme offers not only a strong core of major requirements but also a range of options from which students may choose depending on their particular interests and career plans. The core of the degree in Communications is investigation of the praxis of cultural production across a range of media and creative enterprises and inquiry into the impact of national, ethnic and cultural grounding on concepts and practice of human expression. Optional courses reflect student interests in the specialized areas of PR and Corporate Communication, Media Studies and Media Production, as well as additional options in artistic expression through studio art or performance, the medium of computer graphics or journalism. Thus, students may choose from a variety of specialized studies those which most closely match their talents and interests.

Additionally, the degree program is unique in its intercultural and multicultural focus. Students interact with and gain understanding from other students from over 100 nations, in which no single national group predominates, bringing a knowledge and awareness of the “global village” and its implications on world communication systems and processes. Focusing on critical issues such as globalisation, developing technologies and the growing interdependence of different cultures, Communications students at Richmond participate in a substantive study of new communications research from multicultural frameworks. In keeping with the international mission of this liberal arts university, students are guided towards developing critical thinking and engagement with analysis of the mass media and enquiry regarding culture, race and gender differences.

New technology has transformed the world. It is changing the way we work so rapidly that we run the risk of what we learn today becoming obsolete by tomorrow. It is bringing ideas and people closer together, yet it is only those that achieve a true understanding of the subtleties of intercultural communication who will benefit from the potential that science offers us. The Richmond degree in Communications is a progressive and dynamic program which owes much of its success to constantly updated technology-based courses. The discipline's practice includes videography, scriptwriting, TV production writing, graphics, photography, and computer-aided communication such as multimedia design, and writing for the Internet and world-wide web. Throughout the degree, students are encouraged to work independently and in teams on creative, technology based products which reflect and build on their theoretical knowledge and on their developing practical skills. In this they have the opportunity to exploit the multi-media resources on offer at the university. These practical courses give students the opportunity to focus on a specific career path before they graduate.

Study in communications at Richmond prepares students in the areas of adaptive competence, critical thinking, aesthetic sensibility, professional identity and ethics, and leadership capability – all areas that are necessary for success in today's world. Thus the Richmond BA (Hons) Communications with Combined Studies degree, with its unique intercultural focus, enables students to respond appropriately and effectively to a rapidly changing world and to master the skills necessary for success in the 21st century.

2.2. Subject benchmarks

Communication, Media, Film and Cultural Studies (2016)

See

<http://www.qaa.ac.uk/assuring-standards-and-quality/the-quality-code/subject-benchmark-statements/honours-degree-subjects>

2.3. Internal contexts

BA (Hons) Communications with Combined Studies features:

Detailed published educational objectives that are consistent with the mission of the institution: All course outlines contain course specific objectives that are regularly monitored by the individual instructors and by the Communications faculty as a group.

Processes based on the needs of the programme's various constituencies in which the objectives are determined and periodically evaluated: Each degree's Annual Programme Evaluation (APE) is a central element of Richmond's internal quality assurance and enhancement processes. APEs measure the academic quality and standards of the programme, identify good practice, record any issues to be

addressed, and, from year to year, track the ways in which those issues have been addressed. During the APE process, the academic schools:

- consider student input via course evaluations;
- consider any formalized faculty course evaluations conducted;
- consider all External Examiner reports;
- examine the Programme Specification, and note any changes required;
 - any major changes (“those which change the basic nature of the programme or student experience”) to existing programmes are approved by Academic Board.

A curriculum development process that assures the achievement of the programme’s objectives, and a system of ongoing evaluation that demonstrates achievement of these objectives and uses the results to improve the effectiveness of the programme: Ongoing evaluation is carried out independently by departmental members (when updating courses) and by students (during regular faculty-student meetings). The Academic Board closely analyses the APEs of all degree programmes, and The University’s response to the AMR is considered at the Schools and at Academic Board. An additional formal and substantive review takes place every five years during the revalidation process of Richmond’s degree programmes.

2.4. External contexts

BA (Hons) Communications with Combined Studies is provided through a system of ongoing evaluations that demonstrate achievement of the programme’s objectives, and uses the results to improve the effectiveness of the programme. Ongoing evaluation is carried out for both US (the Middle States Commission on Higher Education) and UK (QAA) reviews.

Richmond is a voluntary subscriber member of the QAA, and underwent its first full Institutional Review in May 2013 and a Higher Education Review (AP) in 2017 (<http://www.richmond.ac.uk/content/admissions/about-richmond/american-british-accreditation.aspx>).

Staff all belong to professional organizations such as the Inter-university Academic Literacies group, the Association for Cultural Studies (ACS), Royal Historical Society, the British Association of American Studies (BAAS), the British Association of Lecturers in English for Academic Purposes (BALEAP), the International American Studies Association (IASA), Editorial Board of Gender and Education Journal, etc.

Students are encouraged to attend meetings, lectures at other London universities, institutions, think-tanks, agencies and organisations as is appropriate.

3. Programme outcomes

Programme-level learning outcomes are identified below. The Communications degree at Richmond the American International University in London is a four year programme where the discipline is studied alongside a range of other subjects. Progression through the Communications degree is set out down each of the four columns of the Programme Outcome grid – with level-specific programme outcomes at the 3000, 4000, 5000 and 6000 level. The programme outcomes are then applied in each course on the Communications degree through assessed, courses-specific learning outcomes. The four broad categories of Programme Outcomes are:

- A. Theoretical Knowledge Base
- B. Practical Knowledge Base
- C. Cognitive Skills
- D. Personal Development

Refer to Appendix I – Curriculum Map for details of how outcomes are deployed across the study programme.

3.1. Key Programme Outcomes

Upon completion of the BA (Hons) Communications (with pathways in Marketing Communications & PR, Media Production and Media Studies) degree, students should be able to demonstrate:

- An understanding of communication and the media and the role they play in different societies.
- An understanding of production processes and professional practices relevant to media and communicative industries.
- The ability to organise and manage supervised, self-directed projects, through which a sophisticated understanding of research methods is demonstrated.
- Skills which will translate into the workplace.

3.2. Theoretical Knowledge Base (“A”)

Includes:	<i>knowledge base, debates in field</i>
LEVEL 3	
A3(i)	an understanding of the history of communication and major media technologies, and a recognition of the different ways in which the history of, and current developments in, media and communication can be understood in relation to technological change
LEVEL 4	
A4(i)	a broad comparative understanding of the roles that media and/or cultural institutions play in different societies
A4(ii)	a broad understanding of the roles of cultural practices and cultural institutions in society

A4(iii)	a broad understanding of particular media forms and genres, and the way in which they organise understandings, meanings and affects
LEVEL 5	
A5(i)	a detailed understanding of the ways in which different social groups may make use of cultural texts and products in the construction of social and cultural realities, cultural maps and frames of reference.
A5(ii)	a detailed understanding of the historical development of practices of cultural consumption (including subcultural forms and everyday lived practices)
A5(iii)	engage critically with major thinkers, debates and intellectual paradigms within the subject area and put them to productive use
LEVEL 6	
A6(i)	a systematic understanding of the historical evolution of particular genres, aesthetic traditions and forms, and of their current characteristics and possible future developments
A6(ii)	a systematic understanding of the history of communication and media technologies, and a recognition of the different ways in which the history of, and current developments in, media and communication can be understood in relation to technological change
A6(iii)	a systematic understanding of new and emergent media forms and their relation both to their social context and to earlier forms
A6(iv)	a systematic understanding of the interconnectedness of texts and contexts, and of the shifting configurations of communicative, cultural and aesthetic practices and systems

3.3. Practical Knowledge Base (“B”)

Includes:	<i>practical applications of knowledge base, principles of practice</i>
LEVEL 3	
B3(i)	an understanding of the processes linking production, distribution, circulation and consumption
LEVEL 4	
B4(i)	a broad understanding of the relationship between discourse, culture and identity.
B4(ii)	a broad insight into the cultural, economic and social ways in which aesthetic judgements and decision making processes are constructed in alternative and corporate media and a demonstrated capacity to work within such constraints
B4(iii)	a broad understanding of the narrative processes, generic forms and modes of representation at work in media and cultural texts while also demonstrating the ability to produce work which effectively manipulates sound, image and/or the written word
LEVEL 5	
B5(i)	a detailed awareness of how media products might be understood and consumed within broader concepts of culture and knowledge of how to effectively produce these products showing capability in operational aspects of media production technologies, systems, techniques and professional practices
B5(ii)	a detailed understanding of the ways in which forms of media and cultural consumption are embedded in everyday life, and serve as ways of claiming and understanding identities

B5(iii)	a detailed understanding of the relationship between discourse, culture and identity
LEVEL 6	
B6(i)	a systematic understanding and application of key production processes and professional practices relevant to media, cultural and communicative industries, and of ways of conceptualising creativity and authorship
B6(ii)	a systematic insight into the cultural and social ways in which aesthetic judgements are constructed and aesthetic processes experienced
B6(iii)	a systematic understanding of the ways in which people engage with cultural texts and practices and make meaning from them
B6(iv)	a systematic understanding of the relationship between discourse, culture and identity

3.4. Cognitive Skills (“C”)

Includes:	<i>critical thinking, synthesis, problem solving, research, analysis</i>
LEVEL 3	
C3(i)	demonstrates the ability to gather, organise and deploy ideas and information in order to communication arguments effectively in written, oral or other forms, with an understanding of appropriate methods
LEVEL 4	
C4(i)	demonstrates the ability to gather, organise and deploy ideas and information in order to evaluate their strengths and weaknesses, and express them effectively in written, oral or other forms
C4(ii)	demonstrates a broad understanding of quantitative and/or qualitative research methods
C4(iii)	demonstrates an ability to judge the reliability of sources, and begins to identify the strengths and weaknesses of concepts and theoretical frameworks
LEVEL 5	
C5(i)	demonstrates the ability to formulate and synthesize arguments cogently, retrieve and generate information, and select appropriate criteria to evaluate sources, with a detailed understanding of quantitative and/or qualitative methods
C5(ii)	delivers work with limited supervision to a given length, format, brief and deadline, properly referencing sources and ideas and making use, as appropriate, of a problem-solving approach
C5(iii)	exercises a degree of independent and informed critical judgement in analysis
LEVEL 6	
C6(i)	demonstrates the ability to gather, organise and deploy complex and abstract ideas and information in order to formulate arguments cogently, and express them effectively in written, oral or other forms
C6(ii)	demonstrates the ability to organise and manage supervised, self-directed projects, through which a sophisticated understanding of research methods is demonstrated
C6(iii)	demonstrates the ability to produce detailed analyses of competing perspectives and concepts, to make comparisons and connections and to identify the possibility of new concepts

C6(iv)	demonstrates the ability to provide critically appraisals of some of the widespread common sense understandings and misunderstandings of the subject area, and the debates and disagreements to which these give rise
---------------	---

3.5. Personal Development (“D”)

Includes:	<i>personal development, engagement with feedback, interpersonal comm skills, levels of independence and autonomy, task completion, team work, ethical and intercultural awareness skills</i>
LEVEL 3	
D3(i)	demonstrates an awareness of views other than their own and adapts behaviour to meet obligations in personal and/or group outcomes and/or outputs
LEVEL 4	
D4(i)	acts with limited autonomy under direction or supervision and engages in evaluation of own work and capabilities and outputs in key areas
D4(ii)	demonstrates broad skills that are relevant to the workplace, including the ability to work productively in a group or team, and to recognise factors that affect performance, including changing contexts, audiences and degrees of complexity
D4(iii)	demonstrates the ability to use a range of information communication technology (ICT) skills to perform tasks
LEVEL 5	
D5(i)	demonstrates well-developed skills that will translate into the workplace, including the ability to work effectively within a group or team, to engage in self-reflection, and to adapt own actions and interpersonal communication skills to changing contexts, audiences and degrees of complexity
D5(ii)	delivers work with limited direction or supervision, demonstrating the capacity to consider and evaluate their own work using justifiable criteria
D5(iii)	demonstrates the ability to adapt to complex and non-routine performance tasks using information communication technology (ICT)
LEVEL 6	
D6(i)	demonstrates the ability to act with minimal direction or supervision, to engage in self-reflection, use feedback to analyse own capabilities, appraise alternatives, and plan and implement actions
D6(ii)	demonstrates personal responsibility and professional codes of conduct, while taking responsibility for their own work, learning and development, and effectiveness in professional and interpersonal communication
D6(iii)	demonstrates flexible skills that translate directly into the workplace, including the ability to plan and manage for changing contexts, audiences and levels of complexity, and advanced group or team work capacities, for example listening, contributing, leading, negotiating and proactively managing conflict as is appropriate
D6(iv)	demonstrates the ability to flexibly locate their own normative views and cultural commitments within the practice of research, with a level of autonomy

The transferable skills acquired in this program equip the students with skills and knowledge to enable them to undertake careers (or further training for careers) in the creative media industries, corporate communications, international marketing, commercial art and journalism.

4. Teaching, learning and assessment strategies

4.1. Teaching and learning strategy

The teaching and learning strategy adopted within **BA (Hons) Communications with Combined Studies** is as follows:

- Teaching is through lectures, seminars, tutorials, and workshops
- Regular use of individual and /or team based projects
- Use of audio-visual aids and a variety of multi-media sources
- Exposure to a range of technologies including graphics, video/editing, photography, multi-media production
- Regular use of individual and/or group presentations
- Regular use of self-directed and directed reading in all courses
- Use of Library resources, including digital resources and online catalogue
- Use of occasional guest lecturers from specialist areas
- Frequent feedback on coursework and through one to one meetings with faculty and small group discussions
- Regular use of tutor and student led discussions groups via e-learning platforms such as Blackboard in many courses
- Using London as a resource

The combination of teaching and learning approaches mentioned above develops our students' knowledge, thinking skills and practical skills.

Their knowledge is acquired through

- Structured lectures and supporting materials
- Directed reading and use of internet materials
- Independent research

Their thinking skills are developed through

- Conducting research
- Making presentations and preparing other assessments
- Helping others to learn
- Project work employing a problem solving methodology

Their practical skills are gained through

- Application of theory to practice, especially during internships and client based senior projects
- Using information technology to retrieve and manipulate data, images
- Negotiating with others in group projects

4.2. Assessment strategy

Courses in the **BA (Hons) Communications with Combined Studies** usually meet the University Standard Assessment Norms or the Writing Intensive Assessment Norms.

Standard Assessment Norms			
FHEQ level	Richmond/UK Level	Normal number of items (including final exam)*	Total assessment
LEVEL 3	R3000/UK A-level	3-4	1 two-hour final exam plus 2000-2500 words
LEVEL 4	R4000/UK Year 1	3-4	1 two-hour final exam plus 2000-3000 words
LEVEL 5	R5000/UK Year 2	2-3	1 two-hour final exam plus 3000-4000 words
LEVEL 6	R6000/UK Year 3	2-3	1 two-hour final exam plus 3000-4000 words
LEVEL 7	R7000/UK MA	2-3	5000-7000 words

*** Reasonable adjustments should be made for assessment activities such as midterm tests, in- class presentations, group assignments, etc. Any summative assessment activities must be reflected in the final overall assessment count.**

Excluding all atypical courses, the following should apply to all courses:

- All undergraduate courses should include one 2-hour final exam, with exceptions approved by the department.
- Final exams should normally be no less than 25% and no more than 50% of the overall final grade.
- Instructors may not fail a student solely for failing the final exam if all graded activities result in a passing grade for the course.
- Midterm tests are optional
- At Level 3, the normal length per item should be between 500-1000 words, or equivalent (not including finals).
- At Level 4, the normal length per item should be between 1000-1500 words, or equivalent (not including finals).

- At Level 7, word count will need to take into account the inclusion of a final exam.
- Attendance and participation cannot be assessment activities.
- Formative assessments are at the discretion of the instructor and do not count toward the number of items or toward the total word count.

Writing Intensive Assessment Norms			
FHEQ level	Richmond/UK Level	Normal number of items	Total assessment
LEVEL 3	R3000/UK A-level	3-4	3000-3250 words
LEVEL 4	R4000/UK Year 1	3-4	3000-4500 words
LEVEL 5	R5000/UK Year 2	2-3	4500-6000 words
LEVEL 6	R6000/UK Year 3	2-3	4500-6000 words

Courses designated as Writing Intensive differ from the Standard Assessment Norms by:

- No final exam
- The total amount of written words will normally increase by 50%

There are some other exceptions and those courses will follow a Special Programmes (eg. ADM, ARW) or Dissertation table approved on 28 June 2012 by Academic Council. Details of these can be found at: <http://www.richmond.ac.uk/content/academic-affairs/academic-standing.aspx>

For courses that have atypical assessment norms and do not follow one of the approved tables, assessment will first be approved by Learning and Teaching Policy Committee.

Grade Assessment Criteria/Marking Scheme

In order to obtain the **BA (Hons) Communications with Combined Studies**, students must have (amongst other requirements) a cumulative GPA across the entire degree of 2.0. This is a 'C' average. A minimum GPA of 2.0 must also be achieved in all courses taken to fulfil major requirements. For information on the calculation of the final degree classifications, see the myacademics page of the university portal at: <https://my.richmond.ac.uk/myacademics/default.aspx>

Course syllabi documents clarify, for each learning outcome, how that particular learning outcome is assessed, and what the threshold criteria for that particular learning outcome is, specified at the 'C' (GPA 2.0) level (i.e. a passing grade)

There are three 'pass' grades (and 7 sub-categories of 'pass' grade) in the **BA (Hons) Communications with Combined Studies**.

There will be variations within the grade band that will be recorded using +/- qualifiers.

Descriptor	Grade	GPA	Detailed Descriptor
Excellent	A	4.0	Grade A applies only to work which: <ul style="list-style-type: none"> • is of excellent to exceptional standard • demonstrates in-depth knowledge and understanding • demonstrates substantial work and original thought has been involved • makes use of very high quality analysis, synthesis, evaluation and critical appraisal • is organised and structured to a high standard
	A-	3.7	
Good	B+	3.3	Grade B applies to work which: <ul style="list-style-type: none"> • is of good to very good standard • demonstrates sound and good quality of knowledge and understanding • demonstrates good quality analysis, synthesis, evaluation and critical appraisal • indicates an increasing ability to incorporate meaning into the work and understand key theories, debates and criticisms • is well organised and structured
	B	3.0	
	B-	2.7	
Satisfactory	C+	2.3	Grade C applies to work which: <ul style="list-style-type: none"> • is adequate although undeveloped • fulfils the requirements of the project at a foundation level in terms of its quality, analysis and expression • limited level of research and understanding of key theories and debates • is organised and presented in a satisfactory form
	C	2.0	
Below Average	C-	1.7	<ul style="list-style-type: none"> • falls below the threshold criteria • demonstrates limited knowledge and understanding • demonstrates minimal attention to quality, range, and appropriateness of research • normally passing grade at course level
Minimal Achievement	D+	1.3	Grade D applies to work which: <ul style="list-style-type: none"> • is of a poor standard • has been produced without a proper understanding of the brief demonstrating confusion • is weak in content and shows little evidence of thought or application • relies on weak or superficial technique • incorporates insufficient research and/or inappropriate sources • is organised and presented poorly • normally passing grade at course level
	D	1.0	
	D-	0.7	
Fail	F	0	Grade F applies to work which: <ul style="list-style-type: none"> • is of very poor standard • has not been submitted or has been submitted beyond the project deadline • shows a complete lack of content, thought or application • makes no or insufficient use of analysis and relevant skills • is the product of academic misconduct • does not fulfil the brief • failing grade at all levels

5. Programme structure:

5.1. BA (Hons) Communications with Combined Studies

A normal course load per academic year is 30 US credits, equivalent to 120 UK credits. Students complete 30 US/120 UK credits at Level 6 in the major.

Please see degree chart below and refer to **Appendix 2: Programme Structure Flowchart**.

Please note that students must complete all General Education requirements AND a minimum of 120 credits at each FHEQ level. The Gen Ed programme commencing Fall 2015 offers more choice amongst levels, so students and advisors must ensure that both Gen Ed requirements and overall level requirements are satisfied. As long as a minimum 120 credits per level is achieved, Gen Ed Options I and II will be automatically fulfilled.

Table 1: Lower-Division / Levels 3 and 4 Degree Requirements

LOWER-DIVISION REQUIREMENTS			
<i>RQF Level 3</i>		US CREDITS	UK CREDITS
COM 3100	Foundations of Mass Media and Communications	3	12
SCL 3100	Foundations of Sociology	3	12
MGT 3200 or ADM 3160	Foundations of Business (required for MK/PR strand) Foundations of Photography (required for MS and MP strands)	3	12
GEP 3100	Transitions I	3	12
GEP 3101	Transitions II	3	12
GEP 3120	Quantitative Reasoning	3	12
GEP 3140	Scientific Reasoning	3	12
GEP 3160	Creative Expression	3	12
GEP 3180	Research and Writing I	3	12
XXX 3xxx	RQF Level 3 Elective (can be Gen Ed Hum SS requirement)	3	12
RQF Level 3 CREDIT TOTALS		30	120

<i>FHEQ Level 4</i>		US CREDITS	UK CREDITS
COM 4100	Intercultural Communications	3	12
AVC 4205	Introduction to Visual Culture	3	12
plus three of the following:		9	36
ADM 4100	The Language of Art		
COM 4105	Worlds of Music		
COM 4400	Introduction to Advertising Practice		
COM 4405	Communications for PR and Advertising		
COM 4410	Sonic Media Production		
COM 4415	Contemporary London Performance (MP and MS strands only)*		
COM 4420	Writing Science Fiction (MP and MS strands only)*		
DEV 4100	Rich World, Poor World		

FLM 4200	Introduction to Film Studies		
FLM 4205	Film in the Americas		
HST 4405	History of Fashion		
JRN 4200	Introduction to Writing for the Media		
MKT 4200	Introduction to the Business of Fashion		
SCL 4110	Gender and Culture		
And all of the following			
GEP 4180	Research and Writing II	3	12
XXX 4xxx	FHEQ Level 4 Elective (can be Gen Ed Hum SS requirement)	3	12
XXX 4xxx	FHEQ Level 4 Elective	3	12
XXX 4xxx	FHEQ Level 4 Elective	3	12
xxx 4xxx	FHEQ Level 4 Elective	3	12
FHEQ Level 4 CREDIT TOTALS		30	120

Table 2: Upper-Division/Levels 5 and 6 Requirements: Marketing and PR Pathway

UPPER-DIVISION REQUIREMENTS			
FHEQ Level 5		US CREDITS	UK CREDITS
COM 5200	Mass Communications and Society	3	12
COM 5205	Cultural Theory	3	12
COM 5220	Communications for PR and Advertising	3	12
SCL 5200	Social Research	3	12
MKT 5200	Principles of Marketing	3	12
plus 1 of the following:		3	12
ADM 5200	Video Production		
COM 5230	Creating Digital Images		
COM 5215	Political Communications		
COM 5218	Celebrity and Fan Culture		
JRN 5200	Feature Writing		
JRN 5400	Entertainment, Arts and the Media		
MKT 5405	Fashion Marketing and Retailing		
MKT 5410	Psychology of Fashion and Luxury Goods		
And all of the following			
XXX 5xxx	FHEQ Level 5 Elective	3	12
XXX 5xxx	FHEQ Level 5 Elective	3	12
XXX 5xxx	FHEQ Level 5 Elective	3	12
XXX 5xxx	FHEQ Level 5 Elective	3	12
FHEQ Level 5 Credit Totals		30	120
FHEQ Level 6		US CREDITS	UK CREDITS
COM 6200	New Media	3	12

COM 6205	PR and Self-Presentation in the Media	3	12
COM 6296	Senior Seminar 1	3	12
COM 6297	Senior Seminar 2	3	12
COM 6391	Senior Project in Communications	3	12
plus 5 of the following OR Internship and 3 of the following:		15	60
ADM 6435	Web Design		
COM 6400	Fashion and Media		
COM 6962	World Internship in Communications (6 CREDITS)		
COM 6972	Internship in Communications (6 CREDITS)		
FLM 6210	Advanced Digital Video		
FLM 6220	Documentary Theory and Production		
FLM 6400	From Script to Screen		
HST 6205	Pictures of Power		
JRN 6200	Publications Layout		
JRN 6205	Media Ethics		
MKT 6200	Advertising Management		
MKT 6220	Digital Marketing and Social Media		
MKT 6215	Global Marketing Management		
MKT 6220	Digital Marketing and Social Media		
MKT 6225	Ethical Fashion and Sustainability		
MKT 6310	Luxury Brand Management		
FHEQ Level 6 Credit Totals		30	120

Table 3: Upper-Division/Levels 5 and 6 Requirements: Media Studies Pathway

UPPER-DIVISION REQUIREMENTS			
FHEQ Level 5		US CREDITS	UK CREDITS
COM 5200	Mass Communications and Society	3	12
COM 5205	Cultural Theory	3	12
COM 5215	Political Communications	3	12
SCL 5200	Social Research	3	12
plus 2 of the following:		6	24
ADM 5200	Video Production		
AMS 5400	American Television Drama		
COM 5105	Modern Popular Music		
COM 5115	Sociology of Culture and Subculture		
COM 5218	Celebrity and Fan Culture		
FLM 5200	Mainstream Cinema: Studies in Genre		
FLM 5405	Adaptations: Literature and Cinema		
FLM 5410	Gender in Film		
JRN 5200	Feature Writing		
JRN 5400	Entertainment, Arts and the Media		

And all of the following			
XXX 5xxx	FHEQ Level 5 Elective	3	12
XXX 5xxx	FHEQ Level 5 Elective	3	12
XXX 5xxx	FHEQ Level 5 Elective	3	12
XXX 5xxx	FHEQ Level 5 Elective	3	12
FHEQ Level 5 Credit Totals		30	120

FHEQ Level 6		US CREDITS	UK CREDITS
COM 6200	New Media	3	12
COM 6296	Senior Seminar 1	3	12
COM 6297	Senior Seminar 2	3	12
COM 6391	Senior Project in Communications	3	12
plus 6 of the following OR Internship and 4 of the following:		18	72
ADM 6425	Photojournalism		
AMS 6400	Pop to Present: Themes in Contemporary US Art		
COM 6205	PR and Self-Presentation in the Media		
COM 6400	Fashion and Media		
COM 6962	World Internship in Communications (6 CREDITS)		
COM 6972	Internship in Communications (6 CREDITS)		
FLM 6200	Transnational Cinema		
FLM 6230	International Cinema		
HST 6205	Picture of Power		
JRN 6205	Media Ethic and Law		
MKT 6225	Ethical Fashion and Sustainability		
FHEQ Level 6 Credit Totals		30	120

Table 4: Upper-Division/Levels 5 and 6 Requirements: Media Production Pathway

UPPER-DIVISION REQUIREMENTS			
FHEQ Level 5		US CREDITS	UK CREDITS
ADM 5200	Video Production	3	12
COM 5230	Creating Digital Images	3	12
COM 5200	Mass Communications and Society	3	12
COM 5205	Cultural Theory	3	12
SCL 5200	Social Research	3	12
plus one of the following:		3	12
ADM 5405	Photography: Theory and Practice		
AMS 5400	American Television Drama		
FLM 5200	Mainstream Cinema: Studies in Genre		
FLM 5405	Adaptations: Literature and Cinema		

FLM 5410	Gender in Film		
CRW 5200	Scriptwriting		
JRN 5200	Feature Writing		
JRN 5400	Entertainment, Arts and the Media		
And all of the following			
XXX 5xxx	FHEQ Level 5 Elective	3	12
XXX 5xxx	FHEQ Level 5 Elective	3	12
XXX 5xxx	FHEQ Level 5 Elective	3	12
XXX 5xxx	FHEQ Level 5 Elective	3	12
FHEQ Level 5 Credit Totals		30	120

FHEQ Level 6		US CREDITS	UK CREDITS
COM 6200	New Media	3	12
COM 6296	Senior Seminar 1	3	12
COM 6297	Senior Seminar 2	3	12
COM 6391	Senior Project in Communications	3	12
JRN 6200	Publications Layout	3	12
plus 5 of the following OR Internship and 3 of the following:		15	60
ADM 6425	Photojournalism		
ADM 6430	Communication Design: Type		
ADM 6435	Web Design		
ADM 6440	Communication Design: Image		
ADM 6450	Animation and Motion		
COM 6205	PR and Self-Presentation in the Media		
COM 6962	World Internship in Communications (6 CREDITS)		
COM 6972	Internship in Communications (6 CREDITS)		
FLM 6200	Transnational Cinema		
FLM 6210	Advanced Digital Video		
FLM 6220	Documentary Theory and Production		
FLM 6230	International Cinema		
FLM 6400	From Script to Screen		
MKT 6225	Ethical Fashion and Sustainability		
FHEQ Level 6 Credit Totals		30	120

Black = Major requirements

Blue = General Education Liberal Arts Core requirements

Green = Electives/Gen Ed Electives, One of these electives (at RQF L3 or FHEQ L4) must fulfil the Humanities/Social Sciences Gen Ed Elective requirement

Courses in Italy

The following courses in Italy may be used to fulfil your degree requirements subject to advisor approval. You must also inform Registry Services of your intentions so that

these courses may be added into your customised Academic Plan and properly counted against degree requirements. If you are planning on taking courses at one of the Richmond Italian sites, please see your advisor.

Table 5: Marketing and PR Pathway, Italy

		US CREDITS	UK CREDITS
Any Level 3 course in Italy as a RQF Level 3 Elective			
Level 4 course in Italy as FHEQ Level 4 Elective from an approved list			
Level 5 core (direct equivalency)			
MKT 5200/ MKT 5800	Principles of Marketing	3	12
Level 5 plus 1 option			
MKT 5405/ MKT 5810	Fashion Marketing and Retailing	3	12
MKT 5410/ MKT 5805	Psychology of Fashion and Luxury Goods	3	12
COM 5840	Gender and Sexuality in Italian Opera	3	12
COM 5845	Luxury and Fashion in Rome	3	12
COM 5855	Writing for the Media in Italy	3	12
COM 5860	Made in Italy: Symbols/Italian Identity	3	12
FLM 5800	History of Italian Cinema and Society	3	12
SCL 5855	Culture and Style in Italy	3	12
SCL 5810	Women in Italian Society	3	12
SCL 5820	Sociology of Italian Soccer	3	12
Level 5 course in Italy as FHEQ Level 5 Elective from an approved list			
Level 6			
COM 6400/ COM 6805	Fashion and Media	3	12
COM 6861/6862	Internship	3/6	12/24

Table 6: Media Studies Pathway, Italy

		US CREDITS	UK CREDITS
Any Level 3 course in Italy as a RQF Level 3 Elective			
Level 4 course in Italy as FHEQ Level 4 Elective from an approved list			
Level 5 plus 2 options			
COM 5840	Gender and Sexuality in Italian Opera	3	12
COM 5845	Luxury and Fashion in Rome	3	12
COM 5855	Writing for the Media in Italy	3	12
COM 5860	Made in Italy: Symbols/Italian Identity	3	12
FLM 5800	History of Italian Cinema and Society	3	12
SCL 5855	Culture and Style in Italy	3	12
SCL 5810	Women in Italian Society	3	12
SCL 5820	Sociology of Italian Soccer	3	12
Level 5 course in Italy as FHEQ Level 5 Elective from an approved list			
Level 6			
COM 6400/ COM 6805	Fashion and Media	3	12
COM 6861/6862	Internship	3/6	12/24

Table 7: Media Studies Production Pathway, Italy

		US CREDITS	UK CREDITS
Any Level 3 course in Italy as a RQF Level 3 Elective			
Level 4 course in Italy as FHEQ Level 4 Elective from an approved list			
Level 5 plus one option		3	12
COM 5840	Gender and Sexuality in Italian Opera		
COM 5845	Luxury and Fashion in Rome		
COM 5855	Writing for the Media in Italy		
COM 5860	Made in Italy: Symbols/Italian Identity		
FLM 5800	History of Italian Cinema and Society		
SCL 5855	Culture and Style in Italy		
SCL 5810	Women in Italian Society		
SCL 5820	Sociology of Italian Soccer		
Level 5 course in Italy as FHEQ Level 5 Elective from an approved list			
Level 6			
COM 6861/6862	Internship	3/6	12/24

Black = Major requirements

Blue = General Education Liberal Arts Core requirements

Green = Electives/Gen Ed Electives, one of these electives (at RQF L3 or FHEQ L4) must fulfil the Humanities/Social Sciences Gen Ed Elective requirement

Red = Courses taught in Italy

5.2. Exit Award Requirements

An exit award is defined as a lower award than one for which the student is registered. Such an award may be conferred if a student completes part, but not all, of the requirements of the programme for which he or she is registered. Students may not enter the university registered for an exit award.

5.2.1. Associate of Arts Degree in General Studies (US)

The US Associate of Arts (AA) degree can be awarded as an exit degree for those students completing the following minimum requirements.

30 US / 120 UK credits at RQF Level 3
30 US / 120 UK credits at FHEQ Level 4

Of the total number of credits required for the AA degree, 30 US/120 UK credits must be completed at Richmond. Students must obtain a minimum cumulative GPA of 2.0 and a major of 2.0 in order to qualify for this degree. Latin Honours are not applied to the AA Degree.

The requirements for the AA degree are outlined in Table 1 above.

5.2.2. Certificate of Higher Education (UK)

The UK Certificate of Higher Education (CertHE) can be broadly aligned with the US Associate of Arts Degree, but the CertHE does not require the completion of 30 US/120 credits at RQF Level 3. Students who qualify for the AA degree will automatically qualify for the CertHE. But students may qualify for a CertHE without fulfilling the requirements for a US AA degree if they have not completed all of the RQF Level 3 requirements necessary to obtain the AA.

Students may not be awarded more than one exit award (notwithstanding dual accreditation of the AA/CertHE) and Boards will recommend the most relevant one for the individual student circumstance for any student meeting the criteria for an award to be made.

The UK CertHE can be awarded as an exit award for those students completing the following minimum requirements.

120 credits at FHEQ Level 4

- Pass (normally a GPA of between 1.85 and 2.99 for all Level 4 courses)
- Merit (normally a GPA of 3.0 to 3.54)
- Distinction (normally a GPA of 3.55 and above for all level 4 courses)

Of the total number of credits required for the UK CertHE, 15 US/60 UK credits must be completed at Richmond.

The requirements for the UK CertHE are outlined in the section of Table 1 pertaining to FHEQ Level 4 requirements.

5.2.3. Diploma of Higher Education (UK)

The UK Diploma of Higher Education (DipHE) has no US equivalent. The UK DipHE can be awarded as an exit award for those students completing the following minimum requirements.

120 credits at FHEQ Level 4

120 credits at FHEQ Level 5

- Pass (normally a GPA of between 1.85 and 2.99 for all Level 4 courses)
- Merit (normally a GPA of 3.0 to 3.54)
- Distinction (normally a GPA of 3.55 and above for all level 4 courses)

Of the total number of credits required for the UK DipHE, 15 US/60 UK Level 4 credits and 15 US/60 UK Level 5 credits must be completed at Richmond.

The requirements for the UK DipHE are outlined in the sections of Table 1 and Table 2 above pertaining to FHEQ Level 4 and FHEQ Level 5 requirements.

5.3. Minor requirements

Students may select Communications as an optional minor to complement their major field. Both the major and minor will be recorded on the student’s transcript at graduation. At least three of the upper division courses required for a minor must be taken at Richmond. A maximum of three courses only may overlap between a student’s major and any minor.

		US Credits	UK Credits
Minor Requirements		18	72
COM 3100	Foundations in Mass Media and Communications	3	12
COM 5200	Mass Communications and Society	3	12
COM 6391	Senior Project in Communications	3	12
plus one of the following		3	12
COM 4100	Intercultural Communications		
AVC 4205	Introduction to Visual Culture		
plus two upper-division courses from any of the three following Communications degree concentrations/pathways:		6	24

6. Distinctive Features and Regulatory Framework

BA (Hons) Communications with Combined Studies is distinctive in that it broadens the academic experience of the students as a consequence of Richmond’s US Liberal Arts framework and General Education requirements, and deepens it through the sequence of course requirements within the programme. This balance between a core of requirements and a range of choices is a key characteristic of the US system of Liberal Arts undergraduate education. While mapping of the US system onto UK regulatory frameworks has presented another opportunity for quality enhancement, accommodation of the special nature of the US liberal arts degree is achieved in the additional “Combined Studies” designation for each major. Developing this distinctive approach, the Richmond programme aspires to the best theory and practice from both sides of the Atlantic.

The **BA (Hons): Communications with Combined Studies** is operated under the policy and regulatory frameworks of Richmond the American International University in London, the Middle States Commission on Higher Education, the *Framework of Higher Education Qualifications*, and the *UK Quality Code for Higher Education*.

The following sub-sections include the relevant University or institutional policy documents, where applicable.

6.1 Admissions

To be considered for admission, prospective students should:

- normally be at least 17 years old, have completed a minimum of 12 years of schooling, and hold the required grade(s) in a complete US high School Diploma, UK GCE A levels, or other UK or international qualifications deemed equivalent by the University, by the start of the programme;
- have completed an application via UCAS, the Common Application or direct to the University, including a personal statement and academic reference and supplying verification of existing academic and English language attainments as required by the University.

Further details of qualifications accepted and grades required may be found on the University website, noting that these are common to all BA programmes at the University and there is no requirement as to the subject of entry qualifications. Prospective students from the United States should note that SATs are optional but not required. Whilst not routinely required, prospective students may be invited to interview where this is considered necessary in order to fully consider their application.

Prospective students with specific levels of subject achievement in Advanced Placement Tests, GCE A Levels and some other UK and international qualifications may enter with Advanced Credit and be given exemption from certain courses of the programme. Normally, Advanced Credit may be given for a maximum of 30 out of the total 120 (US) credits necessary to complete the programme. The University welcomes also applications from prospective students with previous Higher Education study who, depending on subjects taken and grades achieved, may be given up to 75 Transfer Credits against the total 120 (US) credits necessary to complete the programme.

Students who are not nationals of a majority English-speaking country should normally have achieved CEFR level B2 in a secure English Language test acceptable to the University prior to entry to the programme. At the University's discretion, students in this category who are EEA nationals may be excused this requirement where they have recently undertaken a full time programme of study of at least 2 years duration with English as the medium of instruction.

Prospective students who do not meet the above academic and/or English language requirements may be permitted to enter this programme at the appropriate point after having first satisfactorily completed a Foundation Year and /or Academic English language programme at the University.

Further details of all of the above may be found on the University website, where a comprehensive Admissions Policy and Summary of Practice document is also published (<http://www.richmond.ac.uk/content/admissions.aspx>)

6.2 Assessment

A proper assessment of student learning and progression of skills gained is fundamental to the work of the University. Much of what shapes the University's perspective on this has already been mentioned within section 4.2, above, under Assessment Strategy, which has been shaped in accordance with the expectations outlined in Section B6 of the *UK Quality Code for Higher Education*.

For Assessment, the University also follows the MSCHE [Standards for Accreditation and Requirements of Affiliation](#), in particular, Standard V: Educational Effectiveness Assessment.

6.3 Progression

Progression is built into the Programme Outcomes (Section 3 above), as they are derived from the *SEEC* categories associated with specific levels of the *FHEQ*. Learning outcomes in each individual course are therefore level-specific, ensuring an appropriate structure of progression through the degree, with students at graduation meeting the requirements of the QAA subject benchmarks.

6.4 Placement

The Internship Office the University offers a formal mechanism through which students may receive work-placement opportunities. These placements are supervised, career-related work experiences combined with reflective, academic study that help students apply theoretical knowledge in the workplace. Participation in the internship programme is optional, but students who choose to take up a placement receive academic credit for their placement and associated academic work. For full details of the internship programme, please see: <http://www.richmond.ac.uk/content/academic-programs/internships.aspx>

Expectations with regard to careers education, information, advice and guidance (as outlined in Section B4 of *The UK Quality Code for Higher Education*) are handled by the university's Student Affairs department. This department conducts a variety of career services for students, ranging from resource provision to a CV service, and in particular through the LEAD (Leadership, Education and Development) seminar series. For full details of career services offered to students at Richmond, please see: <http://www.richmond.ac.uk/content/student-affairs/career-services.aspx>.

In addition to these services, the alumni office offers networking opportunities where students may contact alumni working in a variety of fields. The alumni office also offers these services via social media such as LinkedIn and Facebook. Please see: <http://www.richmond.ac.uk/content/alumni.aspx>

6.5 Study abroad and Visiting Students

Richmond students have the option to take a leave of absence and travel away from the university as a 'study abroad'. With 20 partnerships spread over five continents, student are able to select from a wide range of partner. See <https://www.richmond.ac.uk/overseas-study-partners/> for further information and requirements. All courses taken elsewhere must be pre-approved by Registry Services. All such courses are rigorously scrutinized, and only credit from appropriately accredited programmes, earned with a grade of C or above, are accepted for transfer. There are strict requirements regarding the number of courses and at what level may be taken outside of Richmond. Please see under "Graduation Requirements" at: <http://www.richmond.ac.uk/content/academic-affairs/graduation/graduation-requirements.aspx>

Richmond students also have the opportunity to complement their studies in London with a semester, year or summer at one of Richmond's two international Study Centres. The Centres are in Florence and Rome, Italy. Although each centre has a specific academic focus, they both offer intensive study of Italian language and culture. Please see <https://www.richmond.ac.uk/richmond-rome-campus/> and <https://www.richmond.ac.uk/richmond-florence-campus/> for more information.

Richmond classes benefit every semester through the arrival of study abroad students from colleges and universities within the United States. These students, who mostly enrol in classes at levels 5 and 6, very often bring with them a distinct set of values and approaches to learning that can be both enriching and challenging. Richmond faculty have the breadth of experience necessary with which to capitalise on the positive aspects of this class room dynamic. Please note that Study Abroad students register for classes *after* Richmond degree-course students have completed their registration process.

6.6 Student support and guidance

There is a range of student support and guidance, for both academic and general wellbeing, available to students at Richmond. This is accomplished through a range of programmes and services which positively impact learning as well as the total student life experience.

All students have an allocated full-time faculty member who acts as their academic adviser. Academic Advisers have on-going responsibility for students' academic progress, meeting with each advisee at least once per semester. Advisers assist students with registration, enabling smooth progression through the degree. They also advise on postgraduate and career opportunities, and also provide pastoral support in many cases.

A range of Maths, English, Technology and Writing workshops have been established to support students with particular needs in these areas. Librarians are on hand to assist with library use, which includes instruction in web-based resources.

Richmond endeavours to make all practical and reasonable adjustments to ensure students are able to fully participate in the University community. Students who declare a physical disability or a special educational need are supported to ensure the quality of their educational experience meets their individual requirements. SEN students, for instance, receive extra time in examinations, and have the option of writing exams on university-provided computers, and/or of taking exams in a separate room. Please see: <https://www.richmond.ac.uk/study-abroad-at-richmond/students-with-additional-needs/>

The university operates a well-staffed Student Affairs department that provides services intended to support and encourage student welfare, safety and development. This department oversees medical registration of students and provides counseling services. It also organizes a range of extracurricular activities and travel designed to further enhance students' educational experiences. Disciplinary and social grievance procedures are also overseen by this department. For a full description of Student Affairs' activities, please see: <https://www.richmond.ac.uk/student-life/>

Appendix I - Curriculum map

Level 3 -- Communications with Combined Studies (Common to all PATHWAYS within the major)

LEVEL 3	COM 3100	SCL 3100
3A(i)	X	X
3B(i)	X	X
3C(i)	X	X
3D(i)	X	X

Level 4 -- Communications with Combined Studies (Common to all concentrations within the major)

LEVEL 4	COM 4100	AVC 4205	COM 4405	COM 4105	DEV 4100	FLM 4200	FLM 4205	HST 4405	JRN 4200	SCL 4110
4A(i)			X	X			X		X	X
4A(ii)	X		X	X	X			X		X
4A(iii)		X	X	X		X	X	X	X	X
4B(i)	X	X		X	X	X	X	X	X	X
4B(ii)		X	X		X	X	X			X
4B(iii)		X						X		X
4C(i)	X	X	X	X		X	X	X	X	X
4C(ii)								X		
4C(iii)		X	X		X	X	X	X	X	X
4D(i)		X			X	X	X	X		X
4D(ii)	X				X			X		X
4D(iii)	X		X		X				X	

Levels 5 & 6 – MARKETING AND PR PATHWAY

Level 5	COM 5200	COM 5205	COM 5220	MKT 5200	SCL 5200	ADM 5200	COM 5230	COM 5100	COM 5215	COM 5218	JRN 5200	JRN 5400	MGT 5405	MKT 5410
5A(i)			X	X		X	X		X	X	X	X	X	X
5A(ii)		X			X									
5A(iii)	X	X		X	X	X	X	X		X				X
5B(i)					X	X	X				X	X		X
5B(ii)	X	X		X				X	X				X	
5B(iii)		X	X		X			X					X	
5C(i)	X	X		X	X					X	X	X	X	X
5C(ii)		X	X	X	X	X			X		X	X	X	X
5C(iii)	X				X	X	X	X				X		
5D(i)				X	X	X	X		X		X	X	X	X
5D(ii)		X			X	X		X	X	X	X	X	X	
5D(iii)	X		X	X	X	X	X							X

Level 6	COM 6200	COM 6205	COM 6296	COM 6297	COM 6391	ADM 6435	COM 6400	COM 6962/6972 (6 cr)	FLM 6210	FLM 6220	FLM 6400	HST 6205	JRN 6200	JRN 6205	JRN 6210	MKT 6220	MKT 6200	MKT 6215	MKT 6225
6A(I)	X						X			X	X	X		X	X	X	X	X	
6A(II)	X											X				X	X	X	
6A(III)	X	X				X			X		X	X				X	X	X	
6A(IV)			X	X		X		X						X	X	X	X	X	
6B(I)					X	X			X	X	X		X					X	X
6B(II)					X	X	X					X				X	X	X	
6B(III)	X	X	X	X			X	X	X			X				X	X	X	
6B(IV)			X	X				X					X						

6C(I)		X	X	X	X			X	X	X	X	X		X	X	X	X	X	X
6C(II)			X	X	X	X		X					X			X	X	X	
6C(III)			X	X				X					X						X
6C(IV)	X		X	X				X					X		X	X			X
6D(I)		X	X	X		X		X	X				X			X	X	X	X
6D(II)	X		X	X	X	X	X	X	X	X	X	X	X	X	X	X	X	X	X
6D(III)	X				X	X				X			X	X					X
6D(IV)			X	X				X					X	X	X	X			

Levels 5 & 6 – MEDIA STUDIES PATHWAY

Level 5	COM 5200	COM 5205	COM 5215	SCL 5200	ADM 5200	AMS 5400	COM 5105	COM 5110	COM 5115	COM 5218	FLM 5200	FLM 5405	FLM 5410	JRN 5200	JRN 5400
5A(i)			X		X	X	X	X	X	X		X		X	X
5A(ii)		X		X			X	X					X		
5A(iii)	X	X		X	X		X		X	X	X	X	X		
5B(i)				X	X	X								X	X
5B(ii)	X	X	X				X	X					X		
5B(iii)		X		X			X	X			X	X	X		
5C(i)	X	X		X		X		X	X	X	X	X		X	X
5C(ii)		X	X	X	X									X	X
5C(iii)	X			X	X	X	X	X					X		X
5D(i)			X	X	X									X	X
5D(ii)		X	X	X	X	X	X		X	X	X		X	X	X
5D(iii)	X			X	X										

Level 6	COM 6200	COM 6296	COM 6297	COM 6391	ADM 6425	ADM 6430	ADM 6435	ADM 6440	AMS 6400	COM 6205	COM 6400	COM 6962 /72 (6 cr)	FLM 6200	FLM 6210	FLM 6220	FLM 6230	JRN 6210	MKT 6225
6A(i)	X				X				X		X		X		X	X	X	

6A(ii)	X				X				X				X					
6A(iii)	X					X	X	X	X	X		X		X				
6A(iv)		X	X		X		X		X				X				X	
6B(i)				X	X	X	X	X	X					X	X			X
6B(ii)				X	X		X				X	X						
6B(iii)	X	X	X						X	X	X	X	X	X		X		
6B(iv)		X	X						X			X						
6C(i)		X	X	X	X				X	X		X	X	X	X	X	X	X
6C(ii)		X	X	X	X	X	X	X	X			X						
6C(iii)		X	X						X			X	X			X		X
6C(iv)	X	X	X						X			X					X	X
6D(i)		X	X		X	X	X	X		X		X	X	X				X
6D(ii)	X	X	X	X	X	X	X	X	X		X			X	X		X	X
6D(iii)	X			X	X	X	X	X				X		X				X
6D(iv)		X	x		X				x								X	

Levels 5 & 6 – MEDIA PRODUCTION PATHWAY

Level 5	ADM 5200	COM 5230	COM 5200	COM 5205	SCL 5200	ADM 5405	AMS 5400	FLM 5200	FLM 5405	FLM 5410	CRW 5200	JRN 5200	JRN 5400
5A(i)	X	X					X		X		X	X	X
5A(ii)				X	X	X				X			
5A(iii)	X	X	X	X	X	X		X	X	X			
5B(i)	X	X			X	X	X				X	X	X
5B(ii)			X	X						X			
5B(iii)				X	X			X	X	X			
5C(i)			X	X	X		X	X	X			X	X
5C(ii)	X			X	X	X					X	X	X
5C(iii)	X	X	X		X	X	X			X			X
5D(i)	X	X			X	X						X	X
5D(ii)	X			X	X	X	X	X		X	X	X	X

5D(iii)	X	X	X		X	X													
---------	---	---	---	--	---	---	--	--	--	--	--	--	--	--	--	--	--	--	--

Level 6	COM 6200	COM 6296	COM 6297	COM 6391	JRN 6200	ADM 6425	ADM 6430	ADM 6435	ADM 6440	ADM 6450	COM 6205	COM 6962 /72 (6 cr)	FLM 6200	FLM 6210	FLM 6220	FLM 6230	FLM 6400	JRN 6210	MKT 6225
6A(i)	X					X							X		X	X	X	X	
6A(ii)	X					X				X			X						
6A(iii)	X						X	X	X		X	X		X			X		
6A(iv)		X	X			X		X					X					X	
6B(i)				X	X	X	X	X	X	X				X	X		X		X
6B(ii)				X		X		X				X							
6B(iii)	X	X	X							X	X	X	X	X		X			
6B(iv)		X	X		X							X							
6C(i)		X	X	X		X					X	X	X	X	X	X	X	X	X
6C(ii)		X	X	X	X	X	X	X	X	X		X							
6C(iii)		X	X									X	X			X			X
6C(iv)	X	X	X									X						X	X
6D(i)		X	X		X	X	X	X	X	X	X	X	X	X	X				X
6D(ii)	X	X	X	X	X	X	X	X	X	X				X	X		X	X	X
6D(iii)	X				X	X	X	X	X	X		X		X					X
6D(iv)		X	X		X	X												X	

For the following courses see relevant programme specifications:

ADM coded: Art, Design and Media

DEV: coded: Development Studies

HST : coded: History

JRN: coded: International Journalism

MKT, MGT coded: Business Admin

PLT coded: Political Science

SCL coded: Combined Studies

*For the internship course, please see the internship programme specification document for more details

Appendix 2 – Programme Structure Flowchart: BA (Hons) Communications with Combined Studies

A. *MARKETING and PUBLIC RELATIONS Pathway.*

Note: Based on a Freshman entering Richmond with no Transfer Credit and opting for one or two Minor subjects.)

YEAR ONE:

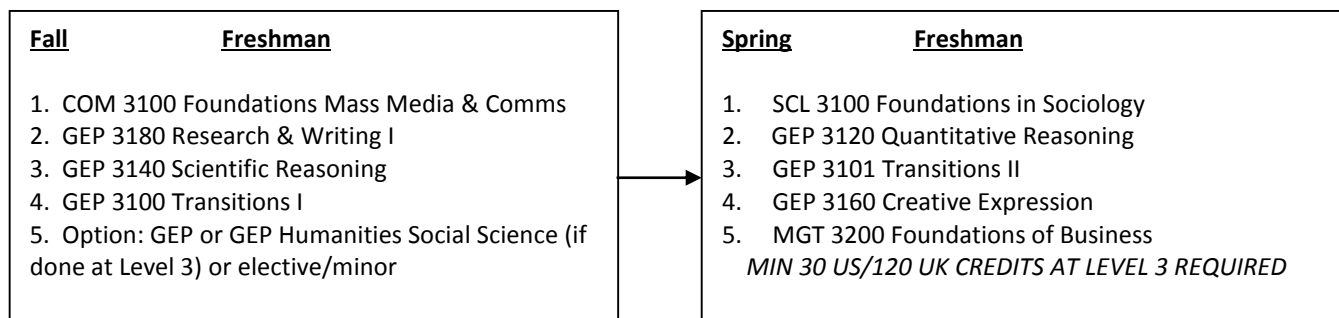

YEAR TWO:

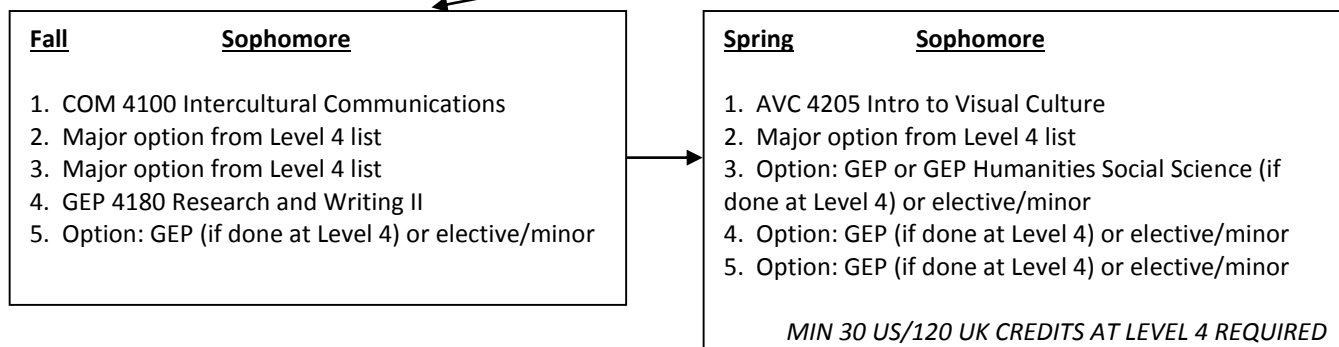

YEAR THREE:

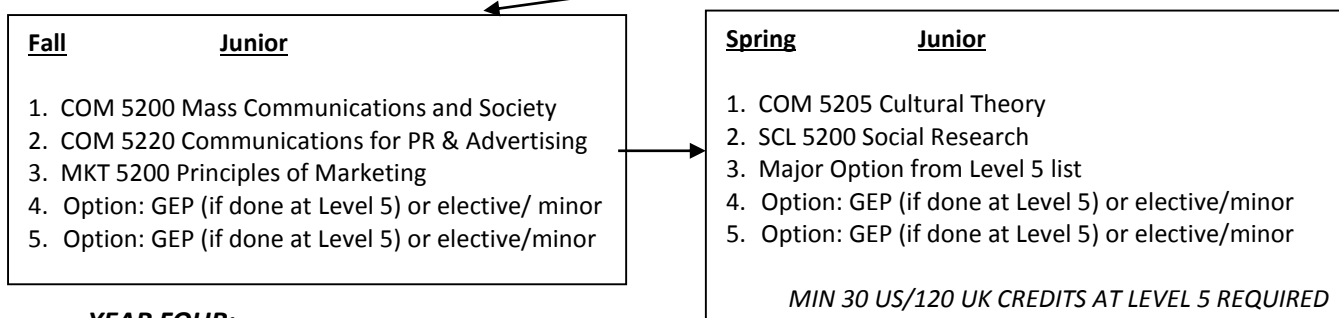

YEAR FOUR:

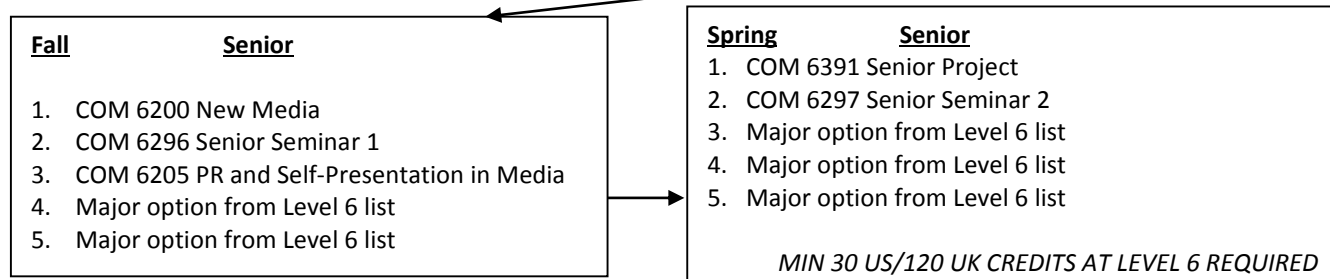

B. MEDIA STUDIES Pathway.

(Note: Based on a Freshman entering Richmond with no Transfer Credit and opting for one or two Minor subjects.)

YEAR ONE:

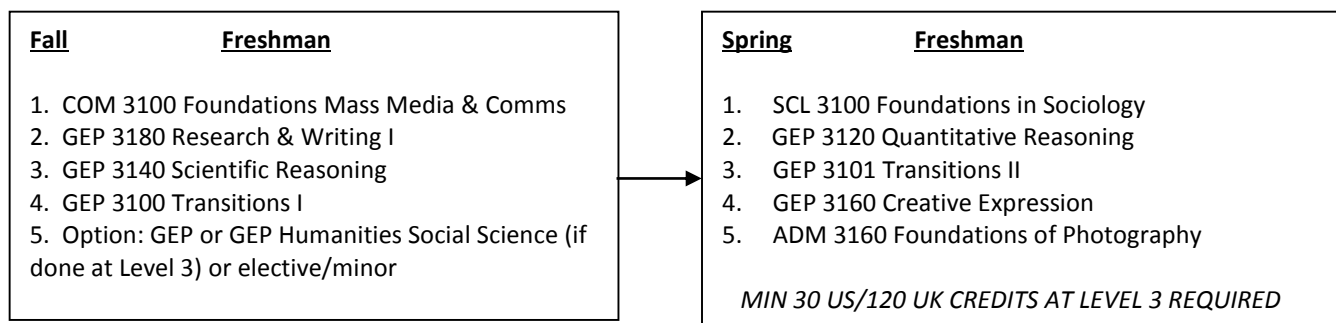

YEAR TWO:

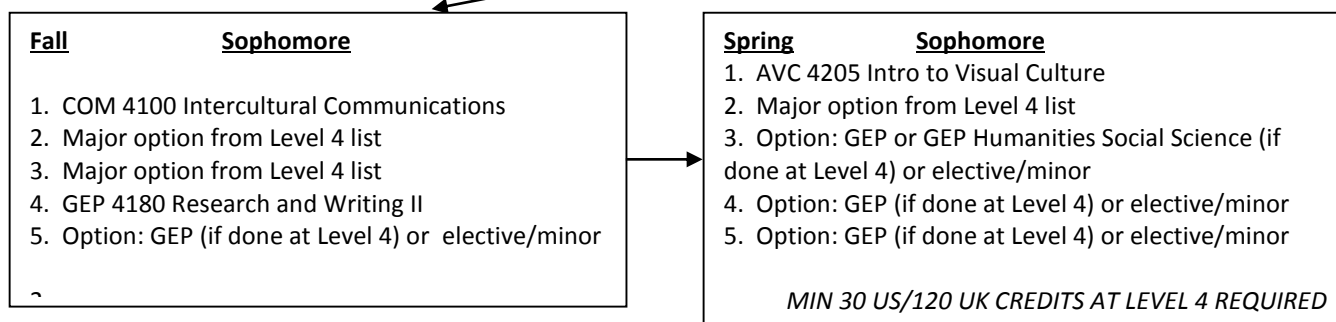

YEAR THREE:

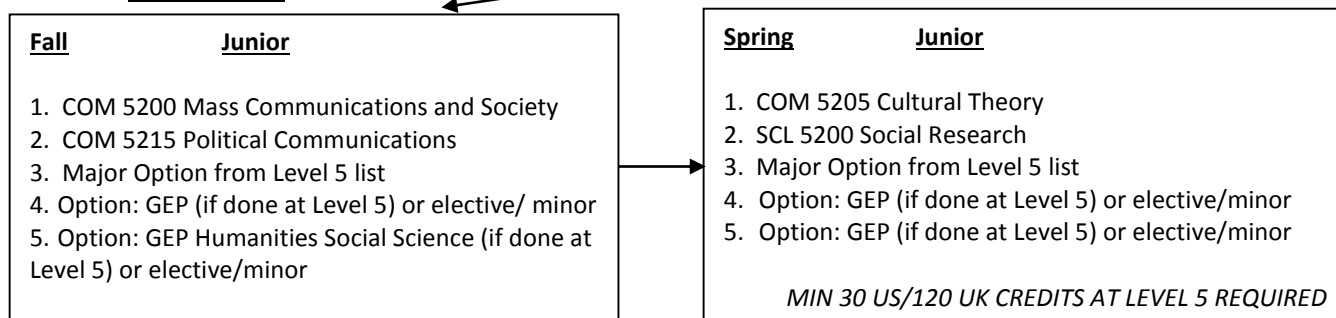

YEAR FOUR:

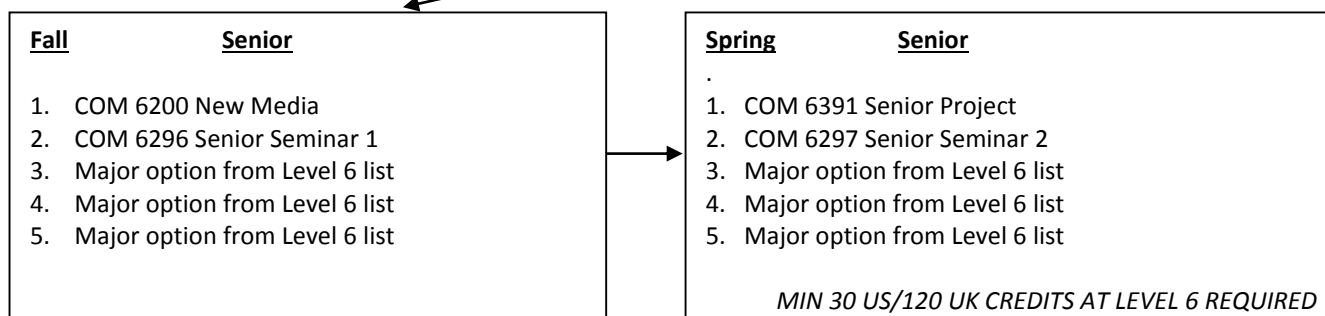

C. MEDIA PRODUCTION Pathway.

(Note: Based on a Freshman entering Richmond with no Transfer Credit and opting for one or two Minor subjects.)

YEAR ONE:

Fall **Freshman**

1. COM 3100 Foundations Mass Media & Comms
2. GEP 3180 Research & Writing I
3. GEP 3140 Scientific Reasoning
4. GEP 3100 Transitions I
5. Option: GEP or GEP Humanities Social Science (if done at Level 3) or elective/minor

Spring **Freshman**

1. SCL 3100 Foundations in Sociology
2. GEP 3120 Quantitative Reasoning
3. GEP 3101 Transitions II
4. GEP 3160 Creative Expression
5. ADM 3160 Foundations of Photography

MIN 30 US/120 UK CREDITS AT LEVEL 3 REQUIRED

YEAR TWO

Fall **Sophomore**

1. COM 4100 Intercultural Communications
2. Major option from Level 4 list
3. Major option from Level 4 list
4. GEP 4180 Research and Writing II
5. Option: GEP (if done at Level 4) or elective/minor

Spring **Sophomore**

1. AVC 4205 Intro to Visual Culture
2. Major option from Level 4 list
3. Option: GEP or GEP Humanities Social Science (if done at Level 4) or elective/minor
4. Option: GEP (if done at Level 4) or elective/minor
5. Option: GEP (if done at Level 4) or elective/minor

MIN 30 US/120 UK CREDITS AT LEVEL 4 REQUIRED

YEAR THREE:

Fall **Junior**

1. COM 5200 Mass Communications and Society
2. ADM 5210 Pixel Playground
3. ADM 5200 Video Production
4. Option: GEP (if done at Level 5) or elective/ minor
5. GEP Humanities Social Science (if done at Level 5) or elective/minor

Spring **Junior**

1. COM 5205 Cultural Theory
2. SCL 5200 Social Research
3. Major Option from Level 5 list
4. Option: GEP (if done at Level 5) or elective/minor
5. Option: GEP (if done at Level 5) or elective/minor

MIN 30 US/120 UK CREDITS AT LEVEL 5 REQUIRED

YEAR FOUR:

Fall **Senior**

1. COM 6200 New Media
2. COM 6296 Senior Seminar 1
3. COM 6391 Senior Project
4. Major option from Level 6 list
5. Major option from Level 6 list

Spring **Senior**

1. COM 6297 Senior Seminar 2
2. JRN 6200 Photojournalism
3. Major option from Level 6 list
4. Major option from Level 6 list
5. Major option from Level 6 list

MIN 30 US/120 UK CREDITS AT LEVEL 6 REQUIRED